



P.O. Box 247, 4320 Aerotech Center Way
 Paso Robles, CA 93447
 Telephone: (800) 350-2223 Fax: (805) 238-4201
 PAGE 1 OF 8 Page Rev. Date: 06-12-20
 P/N: RUBI-UNIV

RUBICRAWLER - JEEP TJ & JK (2007-2011) W/ UNIVERSAL SHIFTER

KIT CONSISTS OF:

<u>No.</u>	<u>Qty</u>	<u>Part No.</u>	<u>Description</u>
1.	1	RUBICRAWLER	- GEAR BOX
2.	1	42R-UNIV	- UNIVERSAL SHIFTER KIT
1	303121	NUT-1/2-13 HX JAM BLACK ZINC	
1	303305	BARREL- TWIN STICK CABLE	
1	303341	BOLT- 1/4"-28 X 5/8" B.H.C.S.	
1	340600	HOUSING- CABLE SHIFTER 4SP	
1	340601	PLATE- SHIFTER HOUSING MOUNT	
1	340602	RING- ATLAS SHIFT BOOT SINGLE STICK	
1	340605	BOOT- SINGLE STICK	
1	340610	RETAINER- ATLAS CABLE SHIFTER BARREL	
1	340611	LEVER- ATLAS 4SP CABLE SHIFTER	
2	340612	BUSHING- CABLE SHIFTER	
1	340614	CLEVIS PIN	
2	340615	BOLT- 1/4"-20 X 5/8" B.H.C.S.	
1	340616	Cotter pin 3/32x 1 zinc	
2	720040	S.H.C.S. 8mm X 1.25 X 20mm	
2	722523	1/4" USS FLAT WASHER PLTD.	
3	722531	1/4"-20 X 1-1/4" H.H.C.S.	
4	722542	SCREW-TEK, HEX SELF DRILLING W/NEO #10 X 1/2"	
1	42R607	SHIFT KNOB - RUBICRAWLER	
1	42R441	Bracket - RubiCrawler cable mount	
1	42R726	HEAT SHIELD- FIREPROOF SLEEVE 1/2"	
1	303309-1	CABLE-ATLAS SHIFTER 48" LENGTH 1" TRAVEL	
2	303313	ROD END- FEMALE 1/4"-28	
1	340617	BOLT- 1/4"-28 X 1" S.H.C.S.	
1	42R320	BRACKET- RUBICRAWLER FOOT MOUNT(JK)	
1	42R580	BRACKET -JK FUEL LINE SUPPORT(JK)	
1	42R581	NUT CLIP ON 6MM(JK)	
1	42R582	S.H.C.S. 6MM-1.00 X 8 MM LONG(JK)	
1	42R460	BRACKET- TJ HEAT SHEILD(TJ)	
1	42R350	- CHRYSLER RTV SEALANT	
1	42R540	- BOLT- M10-1.5 X 30mm BHCS	
4	720015	- WASHER- 10mm FLAT	
10	720028	- BOLT- M10-1.5 X 35mm SHCS	
4	720073	- BOLT- M10-1.5 X 25mm HHCS	

Optional Items:

Part No. Description

42R360 -CHRYSLER ATF+4 (Qty. 4 Recommended)

Tool List:

- FULL SET OF HAND TOOLS INCLUDING:
 6 mm ALLEN WRENCH
 16 mm DEEP SOCKET
 8mm HEX BIT SOCKET
 3/8" DRIVE RATCHET
 15/16" WRENCH
 5/32" ALLEN WRENCH
- 3/8" TORQUE WRENCH
 (25 TO 40 FT.-LBS. REQUIRED)
- GASKET SCRAPER
- SMALL BRASS WIRE BRUSH
- CLEANING SOLVENT
 (PAINT THINNER, ACETONE, MEK ETC) DO NOT USE DEGREASERS LIKE SIMPLE GREEN
- STUBBY 9/16" WRENCH REQUIRED, RATCHETING RECOMMENDED.
- T20, T30, AND T45 TORX BIT SOCKETS.
- SLIDE HAMMER.

SPECIAL NOTE: The components packaged in this kit have been assembled and machined for specific type of conversions. Modifications to any of the components will void any possible warranty or return privileges. If you do not fully understand modifications or changes that will be required to complete your conversion, we strongly recommend that you contact our sales department for more information. This instruction sheet is only to be used for the assembly of Advance Adapter components. We recommend that a service manual pertaining to your vehicle be obtained for specific torque values, wiring diagrams and other related equipment. These manuals are normally available at automotive dealerships and parts stores.

RUBICRAWLER - JEEP TJ & JK (2007-2011) W/ UNIVERSAL SHIFTER

Disassembly/Preparation For Assembly:

1. Use a jack to support the transmission pan to support its weight. Take **caution** to avoid denting the pan and damaging the transmission.
2. Remove the four M8 foot mount nuts from the crossmember.
3. Remove crossmember and any aftermarket skid plates.
4. Remove both drive shafts. Disconnect the breather hose, 4wd switch connector, and the vehicle speed sensor (VSS) connector from the transfer case if your transfer case has them. Disconnect the wiring harness from the tailhousing by prying up the retaining clip on the driver's side of tailhousing. Unbolt the fuel line retaining bracket from the passenger side of the tailhousing.
5. Remove the foot mount from the tailhousing of the transmission by unbolting the four hex head bolts.
6. Remove the transfer case from the vehicle.
7. Remove the spud shaft by following one of the three suggested methods below. The end of the spud shaft is tapped M10-1.5.
 - i. Slide Hammer -(factory service manual method): Note: aggressive use may be necessary.
 - ii. Custom Puller (recommended method)- Make a custom device to span the tailhousing without contacting the end of the shaft. Thread a M10x1.5 bolt through tool and into the spud shaft. (See *Figure 2*)
 - iii. Pry Method (fast but only works on some vehicles)- Use a piece of sheet metal to protect the tailhousing and bolt a large washer to the shaft. Use a pry bar to pry the shaft loose taking care not to damage the tailhousing. (See *Figure 3*)
8. Prepare a drip pan. Removing the tailhousing will result in 2-4 quarts of transmission fluid loss depending on the angle of the drivetrain.
9. Remove the transmission tailhousing by removing the 11 hex head bolts. (See *Figure 4*)
10. Allow oil to drain for 10 minutes.
11. Insert a CLEAN shop rag into the back of the transmission as shown in the picture below to prevent contaminants from entering your transmission. (See *Figure 5*)
12. Thoroughly clean the rear face of the transmission. Use solvent and a brass wire brush to clean



Figure 1: Uni-Raise

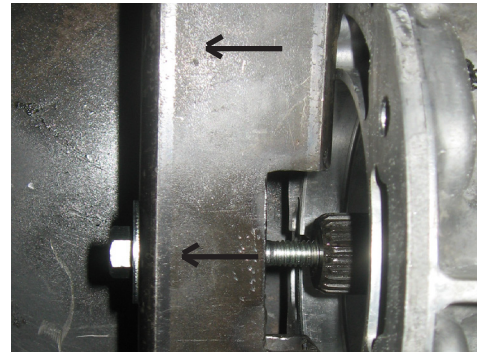

Figure 2: Custom Puller Method

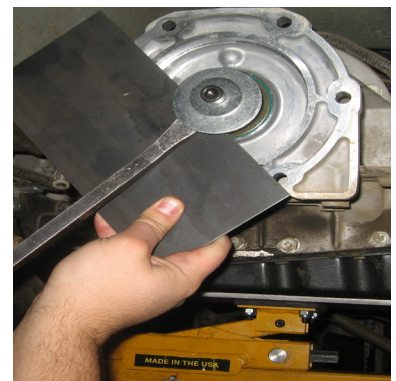

Figure 3: Pry Method

SPECIAL NOTE: The components packaged in this kit have been assembled and machined for specific type of conversions. Modifications to any of the components will void any possible warranty or return privileges. If you do not fully understand modifications or changes that will be required to complete your conversion, we strongly recommend that you contact our sales department for more information. This instruction sheet is only to be used for the assembly of Advance Adapter components. We recommend that a service manual pertaining to your vehicle be obtained for specific torque values, wiring diagrams and other related equipment. These manuals are normally available at automotive dealerships and parts stores.

RUBICRAWLER - JEEP TJ & JK (2007-2011) W/ UNIVERSAL SHIFTER



Figure 4: Transmission Tailhousing

all of the RTV off of the mating face and take caution to avoid any debris from entering the transmission or transmission bearing. (See Figure 6) It may be necessary to trim excess RTV that protrudes up from the transmission pan onto the rear face of the transmission. Excess RTV can prevent the RubiCrawler from fully mating to the transmission face.



Figure 5: Rag Placement

13. Remove the spud shaft retaining clip from the groove near the end of the transmission output shaft.

RubiCrawler Installation:

1. Remove the red plug and O-ring, from the RubiCrawler as seen in Figure 7. Remove the rag from the transmission and discard the red plug.
2. The RubiCrawler should be test fit into the vehicle by installing it without RTV to make sure the RubiCrawler flange face touches the transmission face completely. This is to insure that the output shaft is not too long. The product was designed for a standard output shaft stick-out, but the stick-out could vary which would cause a major problem. If you experience a problem, DO NOT proceed, call Advance Adapters. Steps 3 and 4, are time sensitive and should be completed in under 10 minutes.
3. Reclean the transmission face and the front face of the RubiCrawler using solvent. Apply an 1/8" bead of the supplied Chrysler (ATF+4 compatible) RTV to the RubiCrawler as shown in Figure 8.
4. **Reinstall the O-ring as shown in Figure 8. This is very important for the RubiCrawler and Transmission lubrication circuits.**
5. Lift the RubiCrawler into place, rotate the output shaft until the splines line up and the RubiCrawler slides on, make sure it slides on by hand far enough to squish the RTV. Fasten the RubiCrawler with the 10 sup-

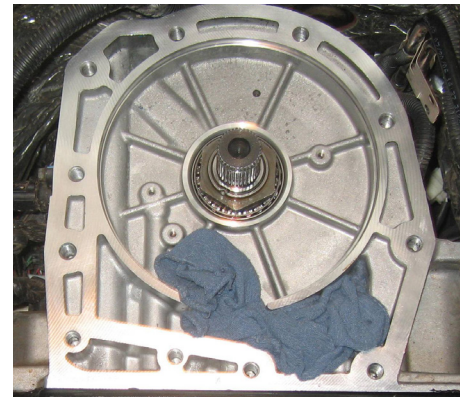

Figure 6: Clean Transmission

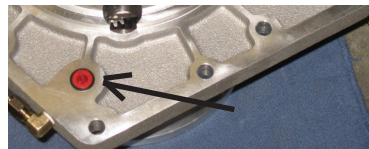

Figure 7: Red Plug

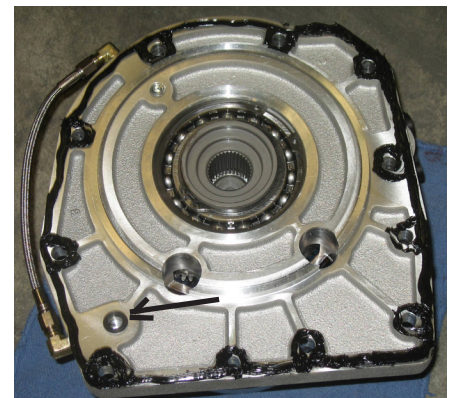

Figure 8: RTV Pattern

SPECIAL NOTE: The components packaged in this kit have been assembled and machined for specific type of conversions. Modifications to any of the components will void any possible warranty or return privileges. If you do not fully understand modifications or changes that will be required to complete your conversion, we strongly recommend that you contact our sales department for more information. This instruction sheet is only to be used for the assembly of Advance Adapter components. We recommend that a service manual pertaining to your vehicle be obtained for specific torque values, wiring diagrams and other related equipment. These manuals are normally available at automotive dealerships and parts stores.

RUBICRAWLER - JEEP TJ & JK (2007-2011) W/ UNIVERSAL SHIFTER

plied 10 mm socket head cap screws using an 8 mm hex bit socket and the 10 mm button head cap screw that bolts on under the shifter box using a 6 mm Allen wrench. Torque all bolts to 40 ft-Lbs.

6. Install the Rubicrawler foot mount using the supplied 10 mm hex head bolts and washers. Torque to 40 ft.-lbs. (See *Figure 9*) Bolt the top half of the factory rubber mount assembly to the RubiCrawler foot mount and the bottom half of the rubber mount to the crossmember. If using any other crossmember than stock, you will have to source your own M10-1.50 bolts to attach to the Rubicrawler foot mount.

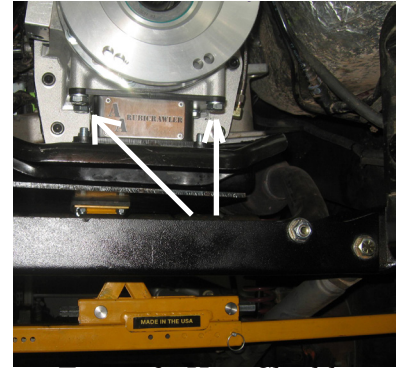
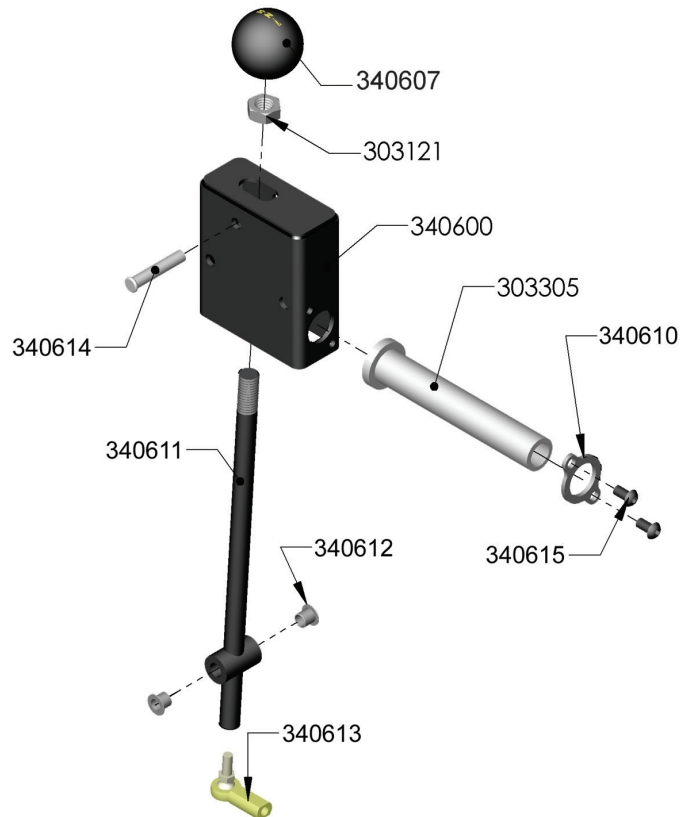

Figure 9: Heat Shield

Bench -Shifter Box Assembly:

1. Press pivot bushings (P/N 340612) into shifter handle (Part No. 340611) using a mallet.
2. Thread ball joint (P/N 340613) into handle and tighten.
3. Slide the shifter handle (P/N 340611) up through bottom of the shifter body (P/N 340600).
4. Insert the clevis pin (P/N 340614) and cotter pin (P/N 340616) for the pivot of the handle.
5. Leave the shift knob and jam nut off until the shifter is mounted in the vehicle.
6. Slide the barrel retainer (P/N 340610) over the long side of the barrel (P/N 303305).
7. Remove the 2nd jam nut & washer from the shift cable housing and thread it into the barrel, about halfway.
8. Thread the 1/4"-28 jam nut completely onto the inner cable.
9. Insert the shift cable and barrel into



SPECIAL NOTE: The components packaged in this kit have been assembled and machined for specific type of conversions. Modifications to any of the components will void any possible warranty or return privileges. If you do not fully understand modifications or changes that will be required to complete your conversion, we strongly recommend that you contact our sales department for more information. This instruction sheet is only to be used for the assembly of Advance Adapter components. We recommend that a service manual pertaining to your vehicle be obtained for specific torque values, wiring diagrams and other related equipment. These manuals are normally available at automotive dealerships and parts stores.

RUBICRAWLER - JEEP TJ & JK (2007-2011) W/ UNIVERSAL SHIFTER

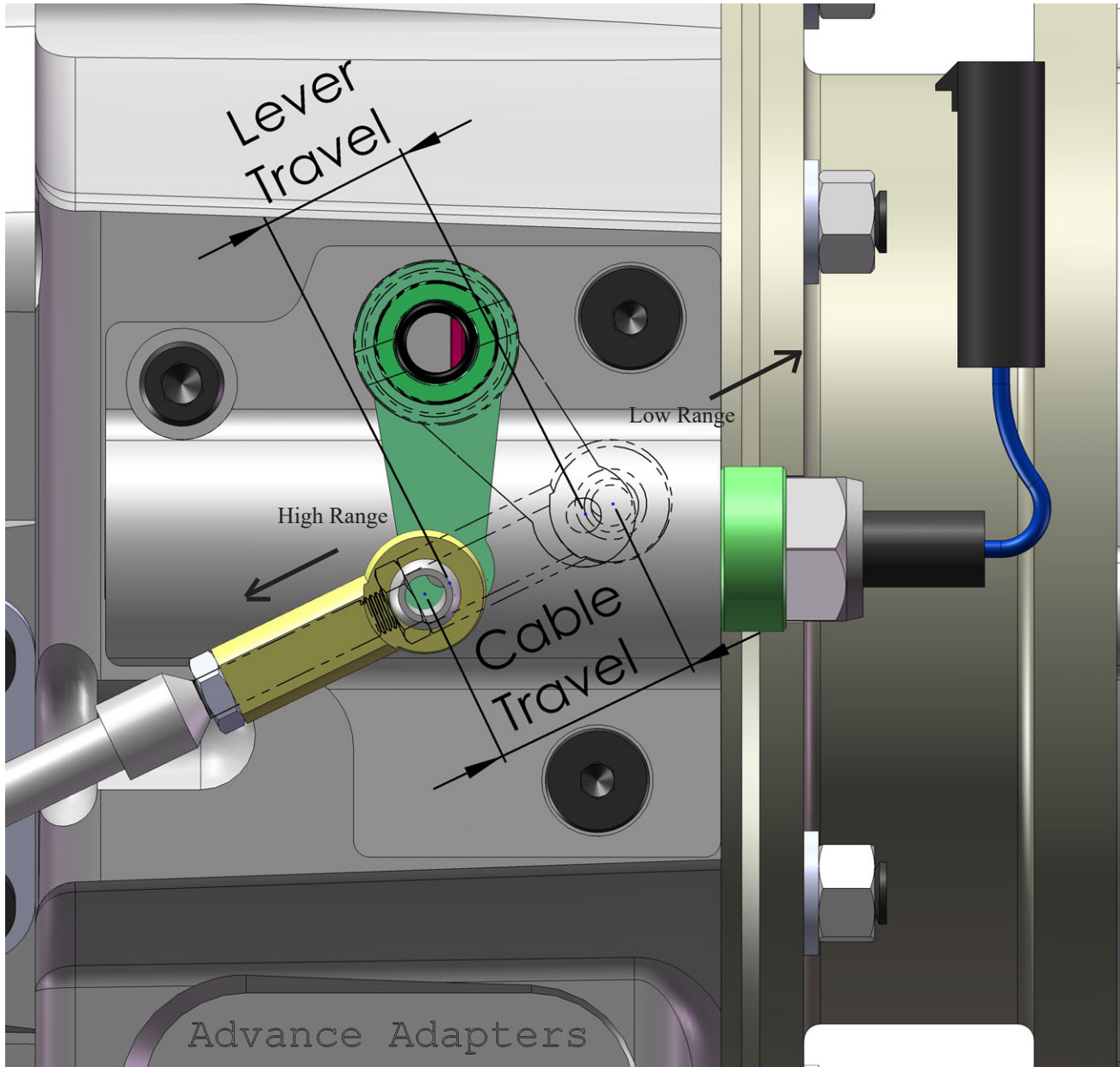

Figure 11: RubiCrawler cable shifter adjustment verification.

See Step 2 of the RubiCrawler Universal Shifter Cable Installation section

SPECIAL NOTE: The components packaged in this kit have been assembled and machined for specific type of conversions. Modifications to any of the components will void any possible warranty or return privileges. If you do not fully understand modifications or changes that will be required to complete your conversion, we strongly recommend that you contact our sales department for more information. This instruction sheet is only to be used for the assembly of Advance Adapter components. We recommend that a service manual pertaining to your vehicle be obtained for specific torque values, wiring diagrams and other related equipment. These manuals are normally available at automotive dealerships and parts stores.

RUBICRAWLER - JEEP TJ & JK (2007-2011) W/ UNIVERSAL SHIFTER

the shifter body. Spin the shift cable to thread the inner cable into the ball joint. When the cable bottoms out in the ball joint, use the jam nut to lock it in place.

10. Seat the barrel into the shifter body and install the barrel retainer with the supplied button head socket cap screws (340615).

RubiCrawler Universal Shifter Installation:

1. Install the RubiCrawler shifter bracket to the flange of the RubiCrawler case using two 8 mm bolts and 1/4" washers supplied with the kit. (See *Figure 12*)
2. Verify that the RubiCrawler cable travels an 1/8" past the mounting hole on the RubiCrawler shift lever for both directions of travel. Use a crescent wrench to shift the RubiCrawler while rotating the output shaft. (See *Figure 11*)
3. Using a medium strength thread locking compound and the supplied 1/4-28x5/8" button head cap screw, bolt the heim joint of the RubiCrawler shift cable to the RubiCrawler shift lever.
4. Mount the Shifter Box Assembly (that was bench assembled previously) in to the vehicle. Pick a location that the cable can reach without kinking or binding. This shifter box was designed to be mounted underneath the vehicle and only requires an approximately 5/8" diameter hole to be made in the floor. Use the shifter mounting plate as a template to drill the three mounting holes in the floor. Insert the three 1/4"-20 x 1.25" bolts through the mounting plate and floor and thread them into the shifter box.
5. Mount the rubber shift boot and boot ring over top of the shifter box.
6. Install the shift knob in the correct orientation onto the shifter handle.

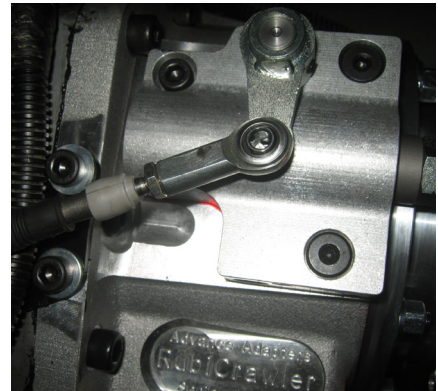

Transfer Case Installation:

1. Verify that the transfer case studs do not bottom out into the rear of RubiCrawler Case. Shorten as needed. Note: If you shorten the studs while on the transfer case, make sure to protect the input shaft area from debris while cutting.
2. Lubricate the lip seal on the back of the RubiCrawler with ATF+4. Shift the transfer case

SPECIAL NOTE: The components packaged in this kit have been assembled and machined for specific type of conversions. Modifications to any of the components will void any possible warranty or return privileges. If you do not fully understand modifications or changes that will be required to complete your conversion, we strongly recommend that you contact our sales department for more information. This instruction sheet is only to be used for the assembly of Advance Adapter components. We recommend that a service manual pertaining to your vehicle be obtained for specific torque values, wiring diagrams and other related equipment. These manuals are normally available at automotive dealerships and parts stores.



P.O. Box 247, 4320 Aerotech Center Way
Paso Robles, CA 93447
Telephone: (800) 350-2223 Fax: (805) 238-4201
PAGE 7 OF 8 Page Rev. Date: 11-06-18
P/N: RUBI-UNIV

RUBICRAWLER - JEEP TJ & JK (2007-2011) W/ UNIVERSAL SHIFTER

into any gear other than neutral. Install the transfer case back into the vehicle by lifting it into place and rotating the rear yoke until the splines engage. Start all nuts before fully indexing the transfer case into the RubiCrawler.

Note: Do not forget to refill the transfer case if any fluid spilled.

3. Make sure that you do not pull the transfer case on by tightening the nuts, push it on completely first by hand. Torque the transfer case nuts to 25-30 ft-lbs.
4. Reinstall the transfer case breather hose, position switch, and the vehicle speed sensor connectors if it has them as well as the shifters.

Reassembly:

1. Reinstall drive shafts and skid plates.

Transmission Fluid Re-Fill:

Caution: under filling or over filling can result in damage to your transmission. Only use Mopar approved, ATF+4 to refill the transmission.

1. Park on a flat surface and apply parking brake.
2. Start the engine and let the vehicle idle.
3. Apply the brakes and shift the transmission through all of the gears, then back to NEUTRAL and leave the vehicle idling.
4. Check the transmission fluid level with the dipstick. Using a clean funnel, add ATF+4 transmission fluid until the oil level is between the two holes marked "COLD". (Check to see if the transmission fluid level on the dipstick is even on both sides. If one side is noticeably higher than the other, the dipstick has picked up some fluid from the fill tube. Allow the fluid to drain down the transmission fill tube and recheck.
5. Now that the fluid level has been approximately achieved, drive the vehicle 5-10 miles making sure to manually shift the transmission through all gears.
6. Recheck the fluid level with the transmission at operating temperature, vehicle idling on flat ground, the parking brake set, and the transmission in neutral. Add ATF+4 to raise the fluid level to a point between the two holes marked "HOT". Do this slowly so that the transmission fill tube has time to drain and gives accurate readings.

NOTE: For proper operation of the RubiCrawler, refer to the Shifting Procedure/Warranty paperwork and the yellow tag attached to the RubiCrawler case.

SPECIAL NOTE: The components packaged in this kit have been assembled and machined for specific type of conversions. Modifications to any of the components will void any possible warranty or return privileges. If you do not fully understand modifications or changes that will be required to complete your conversion, we strongly recommend that you contact our sales department for more information. This instruction sheet is only to be used for the assembly of Advance Adapter components. We recommend that a service manual pertaining to your vehicle be obtained for specific torque values, wiring diagrams and other related equipment. These manuals are normally available at automotive dealerships and parts stores.



P.O. Box 247, 4320 Aerotech Center Way
Paso Robles, CA 93447
Telephone: (800) 350-2223 Fax: (805) 238-4201
PAGE 8 OF 8 Page Rev. Date: 11-06-18
P/N: RUBI-UNIV

RUBICRAWLER - JEEP TJ & JK (2007-2011) W/ UNIVERSAL SHIFTER

SHIFTING INSTRUCTIONS

Transfer Case Shifting: The transfer case can be shifted from two wheel drive to 4 wheel drive HIGH while the vehicle is moving. To shift the transfer case into four wheel drive LOW, you must shift the transmission to neutral and the vehicle speed must be below 2 mph. The transfer case can be shifted at a complete stop but it is easier to shift the unit when at a very slow roll.

RubiCrawler Shifting: The RubiCrawler must be shifted when the transmission is in neutral and the vehicle speed is less than 2 mph. The RubiCrawler can be shifted at a complete stop but it is easier to shift the unit when at a very slow roll. Do NOT try to force the shift levers as serious damage to the shifters or unit can occur.
Serious damage to the RubiCrawler can occur if the proper shifting instructions are not followed.

Shift Knobs and Shift Patterns

The shift knobs and patterns can be seen below and on the next page.

Maximum Speed: The Rubi-Crawler should not be operated at engine speeds above 5000rpm when the transmission is in overdrive. This over speed condition will cause damage to the bearings and geartrain in the RubiCrawler, in addition to possible damage to other components in the vehicle.

ADVANCE ADAPTERS, INC. LIMITED WARRANTY

The RubiCrawler is guaranteed against defects in workmanship and materials for one year. This warranty begins from the date the unit is shipped from Advance Adapters. We log all units with a serial number at time of shipping. The warranty is void (as determined by Advance Adapters, Inc.) by misuse, abuse, improper maintenance or installation and or alterations to the product.

These guarantees do not cover any outside labor, shipping, towing, normal wear or any other unforeseen events that that may occur due to failure of a unit. Advance Adapters reserves the right to repair or replace any product.

Do not disassemble or attempt to repair the RubiCrawler as doing so will void the warranty, just return the product as further described below.

All returns must have a returned goods authorization (RGA#) prior to shipping the product, and returns are to be sent prepaid freight. Please call 1-800-350-2223 and the sales department can assist you.

Warranty will be voided if the proper transmission fluid levels are not maintained, if any transmission fluid other than ATF+4 is used, or the product has not been properly installed and instructions have not been followed.

SPECIAL NOTE: The components packaged in this kit have been assembled and machined for specific type of conversions. Modifications to any of the components will void any possible warranty or return privileges. If you do not fully understand modifications or changes that will be required to complete your conversion, we strongly recommend that you contact our sales department for more information. This instruction sheet is only to be used for the assembly of Advance Adapter components. We recommend that a service manual pertaining to your vehicle be obtained for specific torque values, wiring diagrams and other related equipment. These manuals are normally available at automotive dealerships and parts stores.