



P.O. Box 247, 4320 Aerotech Center Way
 Paso Robles, CA 93447
 Telephone: (800) 350-2223 Fax: (805) 238-4201
 PAGE 1 OF 16 Page Rev. Date: 06-12-20
 P/N: RUBI-TJ

RUBICRAWLER - JEEP TJ W/NP231 & NP241

KIT CONSISTS OF:

No.	Qty	Part No.	Description
1.	1	RUBICRAWLER	GEAR BOX
2.	1	42R-T	TWIN STICK SHIFTER KIT
Kit Includes:			
1.	4	720073	10MM-1.5 X 25 MM FLANGE BOLT
2.	1	303303	RETAINER- SHIFTER BODY BARREL
3.	1	303305	BARREL- TWIN STICK CABLE
4.	1	303309-1	CABLE-ATLAS SHIFTER 48" LENGTH 1" TRAVEL
5.	4	303312	BUSHING- IGUS 3/8"
6.	4	303313	ROD END- FEMALE 1/4"-28
7.	6	303341	BOLT- 1/4"-28 X 5/8" B.H.C.S.
8.	2	303343	Access plug
9.	1	303344	Pivot Dowel Pin (Ground) 2.25"
10	15"	303345	Sealant - Butyl Tape
11	1	303346	BOLT- 1/4"-28 X 5/8" S.H.C.S. plain
12	3	340615	BOLT- 1/4"-20 X 5/8" B.H.C.S.
13	1	42R441	Bracket - RubiCrawler cable mount
14	1	42R460	BRACKET- TJ HEAT SHEILD
15	3	42R617	BOLT- 1/4"-20 X 3/8" B.H.C.S. plain
16	1	42R700	SHIFTER BOX-TJ RUBICRAWLER
17	2	42R701	PIVOT PIN MOUNT
18	1	42R702	BOTTOM COVER
19	1	42R703	HANDLE MOUNT- DRIVER SIDE
20	1	42R704	HANDLE MOUNT-PASSENGER SIDE
21	1	42R705	KNOB- TJ RUBICRAWLER
22	1	42R706	KNOB- NP231
23	1	42R707	LEVER- TJ NP241 TCASE SHIFT
24	1	42R708	LEVER- TC NP231
25	1	42R709	SPRING- WAVE
26	1	42R710	SHIFT KNOB- TJ 241
27	1	42R715	BARREL- CABLE TJ- RUBICRAWLER
28	1	42R725-1	SHIFTER CABLE- 2" TRAVEL
29	2	42R726	HEAT SHIELD- FIREPROOF SLEEVE
30	1	42R730	BRACKET- T-CASE SHIFTER
31	1	42R735	BOLT- 1/4"-20 X 1" H.H.C.S. Grade 8
32	2	42R740	BOLT 8mm X 1.25 X 14mm H.H.C.S. zinc
33	4	42R745	PLUG 7/16" BLACK
34	4	720057	6mm X 1.00 X 16mm H.H.C.S. GRD 8.8
35	4	722513	LOCKWASHER 1/4" PLT.
36	1	722514	NYLON LOCKNUT 1/4"-20
37	2	722523	1/4" USS FLAT WASHER PLTD.
38	2	723753	F.H.C.S. 3/8"-16 X 1-1/4"
39	1	42R350	SEALANT ATF RTV
40	1	42R540	BOLT M10 X 1.5 X 30 BHCS
41	4	720015	10MM FLAT WASHER
42	10	720028	10MM -1.5X 35MM SHCS

Optional Items:

Part No.	Description
42R360	-CHRYSLER ATF+4 (Qty. 4 Recommended)
42R800	-RUBICRAWLER CONTROL MODULE
300474	-Rubber Front Output Yoke Washer

This kit includes shift knobs for both the NP231 and NP241 transfer case. One knob and one shift lever will not be used.

Tool List:

- FULL SET OF HAND TOOLS INCLUDING:
 6 mm ALLEN WRENCH
 16 mm DEEP SOCKET
 8mm HEX BIT SOCKET
 3/8" DRIVE RATCHET
 15/16" WRENCH
 5/32" ALLEN WRENCH
- 3/8" TORQUE WRENCH
 (25 TO 40 FT.-LBS. REQUIRED)
- GASKET SCRAPER
- SMALL BRASS WIRE BRUSH
- CLEANING SOLVENT
 (PAINT THINNER, ACETONE, MEK ETC) DO NOT USE DEGREASERS LIKE SIMPLE GREEN
- STUBBY 9/16" WRENCH REQUIRED,
 RATCHETING RECOMMENDED.
- T20, T30, AND T45 TORX BIT SOCKETS,
 AND A LONG T40 TORX BIT SOCKET
- 15/16" WRENCH
- 5/32" ALLEN WRENCH
- SLIDE HAMMER
- NEEDLE NOSE VICE GRIPS

SPECIAL NOTE: The components packaged in this kit have been assembled and machined for specific type of conversions. Modifications to any of the components will void any possible warranty or return privileges. If you do not fully understand modifications or changes that will be required to complete your conversion, we strongly recommend that you contact our sales department for more information. This instruction sheet is only to be used for the assembly of Advance Adapter components. We recommend that a service manual pertaining to your vehicle be obtained for specific torque values, wiring diagrams and other related equipment. These manuals are normally available at automotive dealerships and parts stores.

RUBICRAWLER - JEEP TJ W/NP231 & NP241

Interior Disassembly:

1. Disconnect the negative terminal of the battery.
2. Remove the cup holder if it is removable, depending on the style of your console.
3. Remove the transmission shift handle by grabbing firmly and pulling straight up until it pops off.
4. Using a small flat head screw driver, remove the transmission shift indicator cover. Once it pops loose you must disconnect the light on the bottom side of the cover to completely remove it. (See *Figure 9 and 10*)
5. Use a 10mm socket to remove the two console bolts located under the cup holder and under the shift indicator panel.
6. Move transfer case handle to 4wd-Low and then pull the console out.
7. Using a flathead screwdriver, remove the wire loom connector clip from the transfer case shifter bracket. (See *Figure 11*)
8. Using an 8mm socket, remove the five transfer case shifter bracket bolts. Make sure to save these bolts as they will be reused.
9. Using a 10 mm socket, remove the four bolts securing the shifter pivot assembly. (See *Figure 12*) You will have to lift up the carpet to get to these bolts. The bracket will fall when the bolts are removed if it isn't held. Seal the bolt holes with the four supplied black plastic plugs.
10. Remove the transfer case shifter and the linkage by lifting it up and out through the floor. (See *Figure 13*)



Figure 9: Transmission Shift Indicator



Figure 10: Indicator Light



Figure 11: Remove Wire Loom Connector Clip



Figure 12: Shifter Pivot Assembly Bolts



Figure 13: Remove Shifter Linkage

SPECIAL NOTE: The components packaged in this kit have been assembled and machined for specific type of conversions. Modifications to any of the components will void any possible warranty or return privileges. If you do not fully understand modifications or changes that will be required to complete your conversion, we strongly recommend that you contact our sales department for more information. This instruction sheet is only to be used for the assembly of Advance Adapter components. We recommend that a service manual pertaining to your vehicle be obtained for specific torque values, wiring diagrams and other related equipment. These manuals are normally available at automotive dealerships and parts stores.

RUBICRAWLER - JEEP TJ W/NP231 & NP241

Disassembly/Preparation For Assembly:

1. Use a jack to support the transmission pan to support its weight. Take **caution** to avoid denting the pan and damaging the transmission.
2. Remove the four M10 foot-mount nuts from the crossmember.
3. Remove crossmember and any aftermarket skid plates.
4. Remove both drive shafts. Disconnect the breather hose, position switch connector, and the vehicle speed sensor (VSS) connector from the transfer case. (See *Figure 2*) Disconnect the wiring harness from the tailhousing by prying up the retaining clip on the driver's side of tailhousing. Also disconnect the shift linkage rod.
5. Remove the foot-mount from the tailhousing of the transmission by unbolting the four hex head bolts and sliding off of the exhaust hanger.
6. Remove the transfer case from the vehicle by removing the 6 nuts from the transfer case studs. Using a stubby 9/16" wrench makes this part much easier.
7. Remove the spud shaft by following one of the suggested methods below. The end of the spud shaft is tapped M10-1.5.
 - i. Slide Hammer -(factory service manual method): Note: aggressive use may be necessary.
 - ii. Custom Puller (recommended method)- Make a custom device to span the tailhousing without contacting the end of the shaft. Thread a M10x1.5 bolt through tool and into the spud shaft. (See *Figure 3*)
8. Prepare a drip pan. Removing the tailhousing will result in 2-4 quarts of transmission fluid loss depending on the angle of the drivetrain.



Figure 1: Uni-Raise

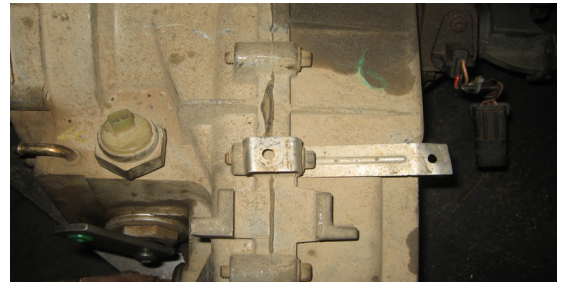

Figure 2: Transfer Case Connectors



Figure 3: Custom Puller Method

RUBICRAWLER - JEEP TJ W/NP231 & NP241

9. Remove the transmission tailhousing by removing the 11 hex head bolts. (See *Figure 5*)
10. Allow oil to drain for 10 minutes..
11. Insert a CLEAN shop rag into the back of the transmission as shown in the picture below to prevent contaminants from entering your transmission. (See *Figure 6*)
12. Thoroughly clean the rear face of the transmission. Use solvent and a brass wire brush to clean all of the RTV off of the mating face and take caution to avoid any debris from entering the transmission or transmission bearing. It may be necessary to trim excess RTV that protrudes up from the transmission pan onto the rear face of the transmission. (See *Figure 7*) Excess RTV can prevent the Rubicrawler from fully mating to the transmission face.
13. Remove the spud shaft retaining clip from the groove near the end of the transmission output shaft. shield bolts on below the two lower passenger side bolts which can be seen in *Figure 25*. Torque all bolts to 40 ft-lbs.

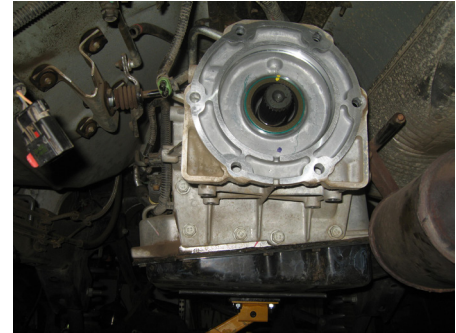

Figure 5: Transmission Tailhousing



Figure 6: Rag Placement

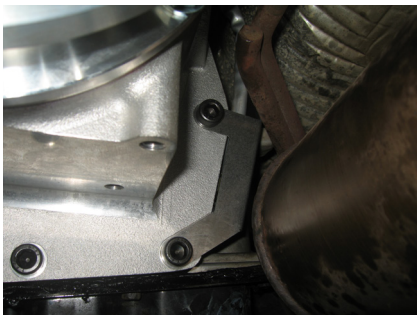

Figure 25: Heat Shield

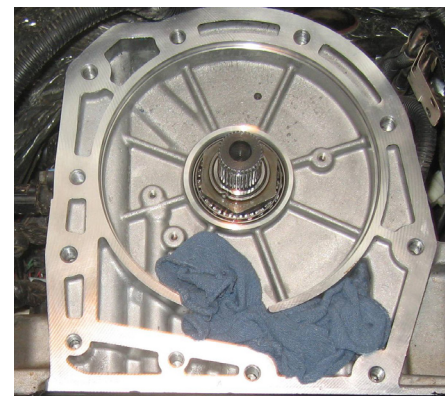

Figure 7: Clean Transmission

SPECIAL NOTE: The components packaged in this kit have been assembled and machined for specific type of conversions. Modifications to any of the components will void any possible warranty or return privileges. If you do not fully understand modifications or changes that will be required to complete your conversion, we strongly recommend that you contact our sales department for more information. This instruction sheet is only to be used for the assembly of Advance Adapter components. We recommend that a service manual pertaining to your vehicle be obtained for specific torque values, wiring diagrams and other related equipment. These manuals are normally available at automotive dealerships and parts stores.

RUBICRAWLER - JEEP TJ W/NP231 & NP241

RubiCrawler Installation:

1. Remove the red plug and O-ring, from the RubiCrawler as seen in *Figure 23*. Remove the rag from the transmission and discard the red plug.
2. The RubiCrawler should be test fit into the vehicle by installing it without RTV to make sure the RubiCrawler flange face touches the transmission face completely. This is to insure that the output shaft is not too long. The product was designed for a standard output shaft stick-out, but the stick-out could vary which would cause a major problem. If you experience a problem, DO NOT proceed, call Advance Adapters. The next two steps are time sensitive and should be completed in under 10 minutes.
3. Reclean the transmission face and the front face of the RubiCrawler using solvent. Apply an 1/8" bead of the supplied Chrysler RTV to the RubiCrawler as shown in *Figure 24*.
4. **Reinstall the O-ring as shown in *Figure 24*. This is very important for the RubiCrawler and Transmission lubrication circuits.**
5. Lift the RubiCrawler into place, rotate the output shaft until the splines line up and the RubiCrawler slides on, make sure it slides on by hand far enough to squish the RTV. Fasten the RubiCrawler with the 10 supplied 10 mm socket head cap screws using an 8 mm hex bit socket and the 10mm button head cap screw that bolts on under the shifter box using a 6 mm hex bit socket. The supplied heat shield bolts on the two lower passenger side. The bolts can be seen in FIG 25. Torque all bolts to 40 FT.-LBS.



Figure 23: Red Plug

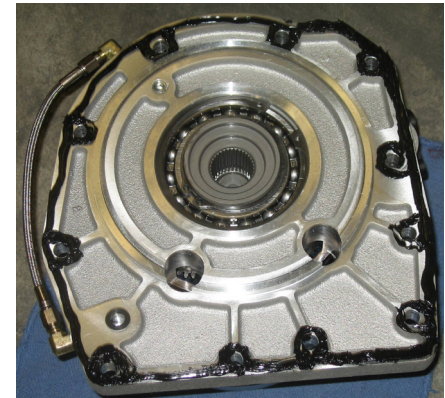

Figure 24: RTV Pattern

RUBICRAWLER - JEEP TJ W/NP231 & NP241

RubiCrawler Shifter Cable Gear Box End Adjustment:

1. Install the RubiCrawler shifter bracket to the flange of the RubiCrawler case using two 8 mm bolts and 1/4" washers supplied with the kit.
2. Verify that the RubiCrawler cable travels an 1/8" past the mounting hole on the RubiCrawler shift lever for both directions of travel. Use a crescent wrench to shift the RubiCrawler while rotating the output shaft. (See *Figure 28*) also see page 8.
3. Using a medium strength thread locking compound and the supplied 1/4-28x5/8" button head cap screw, bolt the heim joint of the RubiCrawler shift cable to the RubiCrawler shift lever.

Transfer Case Installation and Transfer Case Shifter Cable Gear Box End Adjustment:

1. Bolt the transfer case shifter bracket to the side of the RubiCrawler shift housing using the supplied 6mm hex head bolts and 1/4" lock washers. (See *Figure 26*)
2. Route the transfer case shifter cable through the lower transfer case shifter bracket hole with a jam nut on both sides of the bracket and then completely thread the heim joint on to the end of the cable and tighten the jam nut. This cable should already be routed under the transmission cooler lines. (See *Figure 27*)

NOTE: If you purchased the optional Advance Adapters RubiCrawler Control Module (PN: 42R800), now is the best time to install it. Refer to the RubiCrawler Control Module installation instructions for further information.



Figure 26: Transfer Case Shifter Bracket



Figure 27: Cable Shifter Routing

SPECIAL NOTE: The components packaged in this kit have been assembled and machined for specific type of conversions. Modifications to any of the components will void any possible warranty or return privileges. If you do not fully understand modifications or changes that will be required to complete your conversion, we strongly recommend that you contact our sales department for more information. This instruction sheet is only to be used for the assembly of Advance Adapter components. We recommend that a service manual pertaining to your vehicle be obtained for specific torque values, wiring diagrams and other related equipment. These manuals are normally available at automotive dealerships and parts stores.

RUBICRAWLER - JEEP TJ W/NP231 & NP241

3. The stock studs from the transfer case are too long to bolt up to the RubiCrawler. You need to grind the end of the studs down 3/16" (to the first thread), When you grind the studs make sure to protect the input shaft area from debris.
4. (NP241 units only) With the transfer case still out of the vehicle, remove the shift lever. The torx bolt retaining the stock shift lever is difficult to access due to front yoke clearance. Two recommended methods for removing the bolt:
 - i. Use long needle nose vise grips to grab the head of the bolt and attempt to loosen. (See *Figure 29*)
 - ii. Use an 1-1/8" socket and impact gun to remove the yoke nut and yoke. Do not allow any contaminants to enter the transfer case while the yoke is off. Use a long T40 Torx bit and remove the shift lever bolt and then the shift lever. To reinstall the yoke, install a new rubber yoke washer, Chrysler PN: 04210973, in to the yoke splines. Apply a bead of silicone to the inside of the yoke. Apply ATF to the lip of the yoke seal, slide yoke over the rubber washer until it bottoms out in the case. Secure using a new yoke nut, Chrysler PN: 04167924, this is very important as the yoke nuts are designed for one time use, and torque to 110 ft-lbs. (See *Figure 31*)
5. Install the new supplied shift lever with the supplied M8-1.25x14 hex head bolt and 1/4" washer (use a medium strength thread locking compound on the threads) and see *Figure 30* for correct lever orientation. Torque to 20 ft-lbs.
6. Lubricate the lip seal on the back of the RubiCrawler with ATF+4. Shift the transfer case into any gear other than neutral. Install the transfer case back into the vehicle by lifting it into place and rotating the rear yoke until the splines engage. Start all nuts before fully indexing the transfer case in to the RubiCrawler.



Figure 29: Shift Lever Removal with Needle Nose Vise Grips



Figure 30: New Transfer Case Shift Lever Orientation NP241



Figure 31: Proper Yoke Installation Order

SPECIAL NOTE: The components packaged in this kit have been assembled and machined for specific type of conversions. Modifications to any of the components will void any possible warranty or return privileges. If you do not fully understand modifications or changes that will be required to complete your conversion, we strongly recommend that you contact our sales department for more information. This instruction sheet is only to be used for the assembly of Advance Adapter components. We recommend that a service manual pertaining to your vehicle be obtained for specific torque values, wiring diagrams and other related equipment. These manuals are normally available at automotive dealerships and parts stores.

RUBICRAWLER - JEEP TJ W/NP231 & NP241

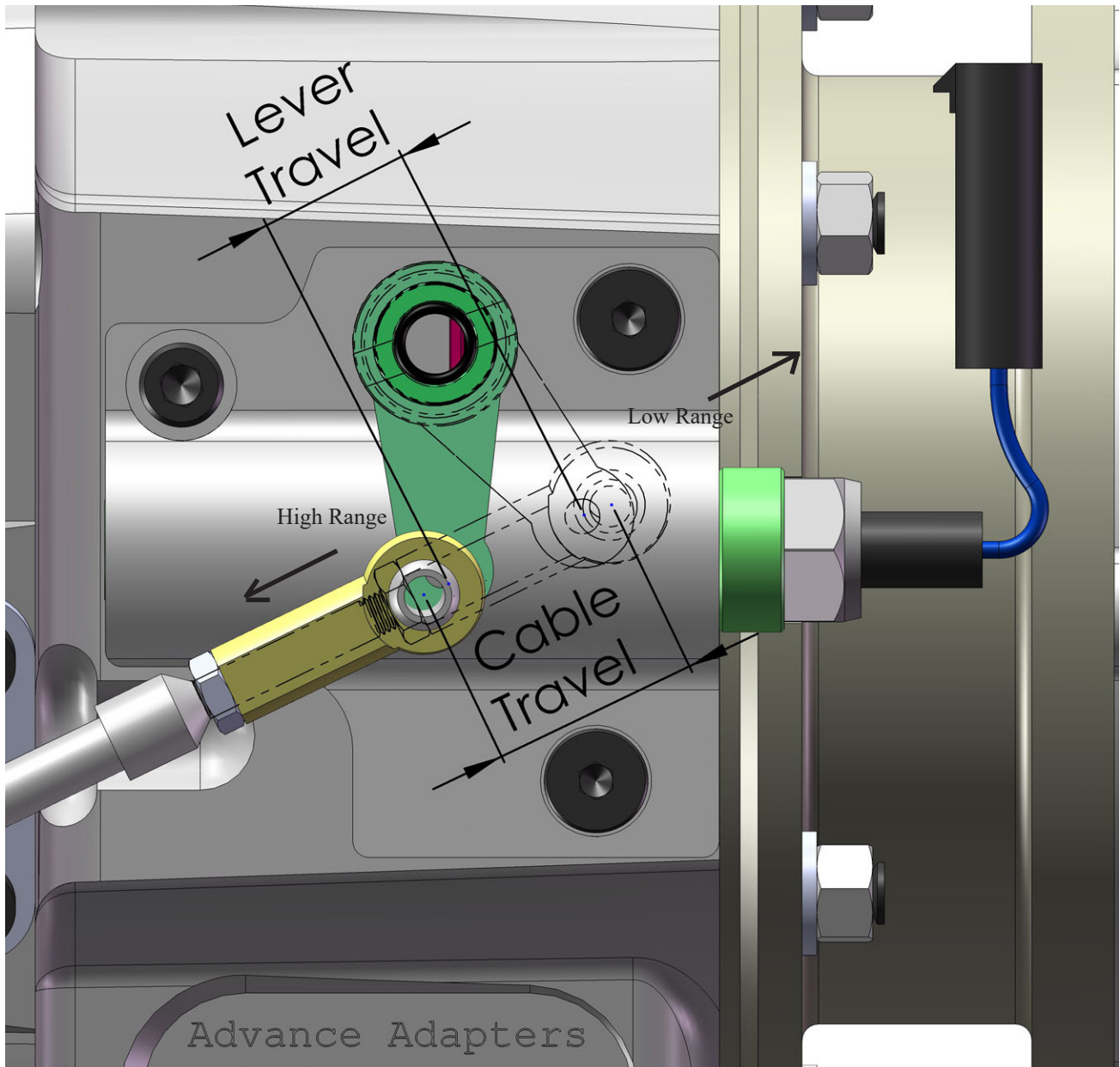
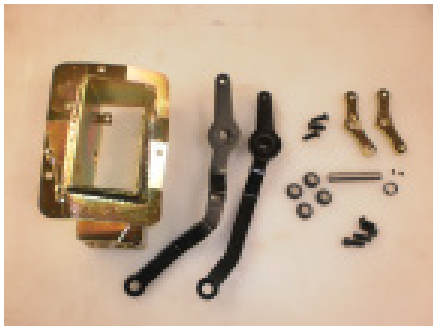

Figure 28: RubiCrawler cable shifter adjustment verification.
See Step 2 of the **RubiCrawler Shifter Cable Gear Box End Adjustment**

SPECIAL NOTE: The components packaged in this kit have been assembled and machined for specific type of conversions. Modifications to any of the components will void any possible warranty or return privileges. If you do not fully understand modifications or changes that will be required to complete your conversion, we strongly recommend that you contact our sales department for more information. This instruction sheet is only to be used for the assembly of Advance Adapter components. We recommend that a service manual pertaining to your vehicle be obtained for specific torque values, wiring diagrams and other related equipment. These manuals are normally available at automotive dealerships and parts stores.

RUBICRAWLER - JEEP TJ W/NP231 & NP241



Shifter assembly components



The Igus bushings must be **pressed** into the shift handles. A arbor press or a light hand with a hammer works well. Once the bushings are installed the pivot pin gets installed through the handles with the wave washer between them.

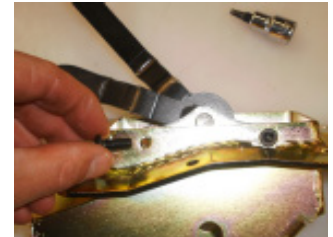

Slide the pivot pin mounts over the pivot pin, make sure the pivot pin is flush with the outside of the pivot pin mount. Use the small set screw to lock the pin to the mount. Check the orientation of the handles and set the handle assembly into the shift housing, the one socket head bolt mounts the rear pivot pin mount to the housing and the other three holes use button head bolts.

SPECIAL NOTE: The components packaged in this kit have been assembled and machined for specific type of conversions. Modifications to any of the components will void any possible warranty or return privileges. If you do not fully understand modifications or changes that will be required to complete your conversion, we strongly recommend that you contact our sales department for more information. This instruction sheet is only to be used for the assembly of Advance Adapter components. We recommend that a service manual pertaining to your vehicle be obtained for specific torque values, wiring diagrams and other related equipment. These manuals are normally available at automotive dealerships and parts stores.

RUBICRAWLER - JEEP TJ W/NP231 & NP241

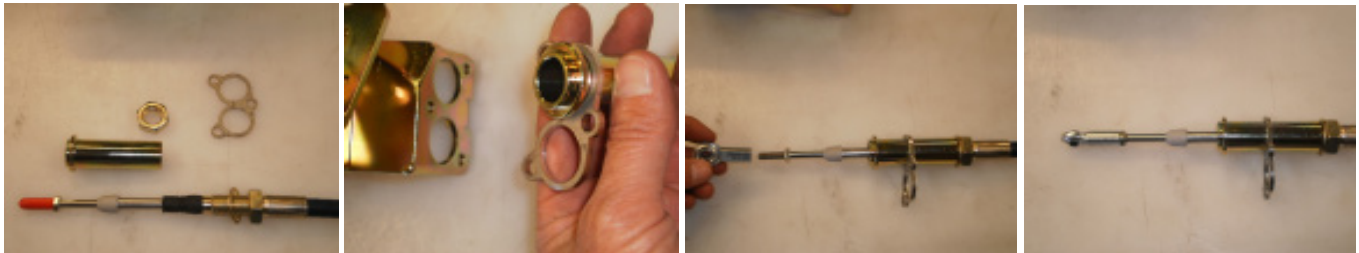

Remove the double nuts on one end of the cable and install the heat shield. Reinstall one of the nuts and the star washer. Take the long barrel retainer and slide the retainer on it, verify the retainer is orientated correctly to bolt to the shifter body. Thread the barrel onto the cable and then install the heim joint to the cable end.

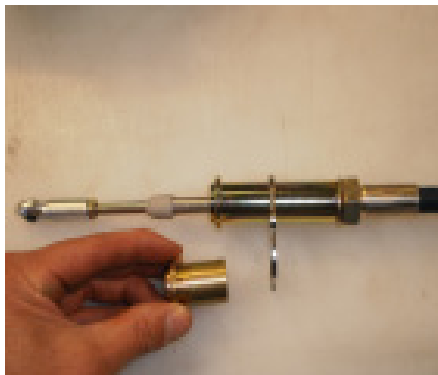

Install the short cable barrel and then mount to the shifter housing. Align the heim joint with the access hole on the shifter housing and the handle, then bolt together with the button head bolt. The plastic cap can be installed after.

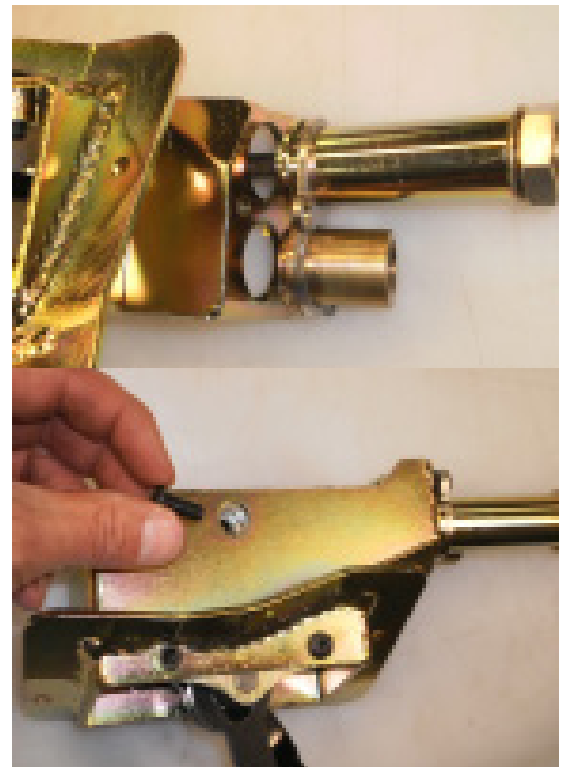
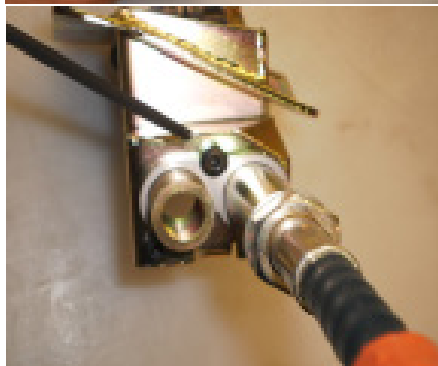

SPECIAL NOTE: The components packaged in this kit have been assembled and machined for specific type of conversions. Modifications to any of the components will void any possible warranty or return privileges. If you do not fully understand modifications or changes that will be required to complete your conversion, we strongly recommend that you contact our sales department for more information. This instruction sheet is only to be used for the assembly of Advance Adapter components. We recommend that a service manual pertaining to your vehicle be obtained for specific torque values, wiring diagrams and other related equipment. These manuals are normally available at automotive dealerships and parts stores.

RUBICRAWLER - JEEP TJ (2003-2006) NON-RUBICONS W/ TWIN STICK SHIFTERS

Shifter Box Assembly End Cable Adjustment:

1. Partially thread the RubiCrawler shift cable into the passenger side barrel mount of the shifter assembly by rotating the cable barrels. (See *Figure 18*)
2. Install the supplied heim joint completely onto the cable that was just mounted and tighten the 1/4-28 jam nut. (See *Figure 19*)
3. Apply a medium strength thread locking compound to the 1/4-28x5/8" button head cap screw and bolt the heim joint just installed to the passenger side shift lever. (See *Figure 19*)
4. Rotate RubiCrawler cable barrel until the shift knob lines up with the edge of the cup holder in its furthest back position, see *Figure 20*. Verify that the RubiCrawler shift lever does not contact the console in its furthest back position.
5. Install the nylon access plug to the passenger side of the shifter box assembly.
6. Rotate the transfer case cable barrel until the center of the knob is 1" from the console when in its lowest position. (See *Figure 21*)
7. Tighten the three 1/4-28x5/8" bolts that retain the cable barrel retaining clip. (See *Figure 22*)
8. Using a 15/16" wrench, tighten the 5/8" jam nuts on the shift cables.
9. Bolt on the bottom cover of the shifter box using the supplied 1/4-20x3/8" button head cap screws. **NOTE:** Make sure you start all 3 before final tightening. Use RTV for a water tight seal.

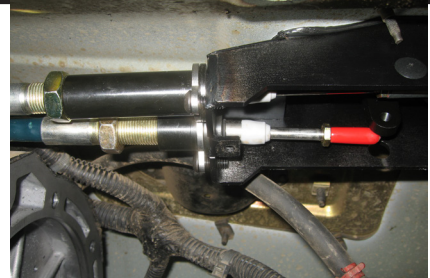

Figure 18: Barrel Mount

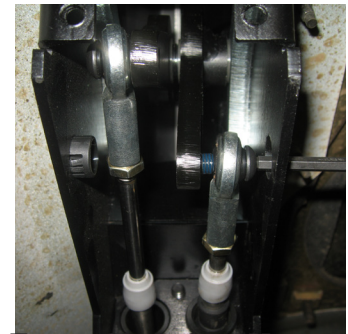

Figure 19: Bolt in Heim



Figure 20: RubiCrawler Shift Knob in Furthest Back Position



Figure 22: Tighten Retaining Clip



Figure 21: 1" from console

SPECIAL NOTE: The components packaged in this kit have been assembled and machined for specific type of conversions. Modifications to any of the components will void any possible warranty or return privileges. If you do not fully understand modifications or changes that will be required to complete your conversion, we strongly recommend that you contact our sales department for more information. This instruction sheet is only to be used for the assembly of Advance Adapter components. We recommend that a service manual pertaining to your vehicle be obtained for specific torque values, wiring diagrams and other related equipment. These manuals are normally available at automotive dealerships and parts stores.

RUBICRAWLER - JEEP TJ W/NP231 & NP241

Note: Do not forget to refill the transfer case if any fluid spilled.

10. Make sure that transfer case fits flush to the RubiCrawler box and you do not pull the units together by tightening the nuts, push it on completely first by hand. Use a stubby 9/16" wrench to torque the transfer case nuts to 25-30 ft-lbs.
11. Adjust the transfer case shifter cable by adjusting the two 5/8" nuts so that the heim travels an 1/8" past the shift lever for both directions of travel. (See *Figure 33*)
12. Attach the cable shifter heim to the previously installed shift lever (See *Figure 30*) using the supplied 1/4-20x1" hex head bolt and a nylock hex nut.
13. Reinstall the transfer case breather hose, position switch, and the vehicle speed sensor connectors.
14. Route the new RubiCrawler cable as shown in the picture. (See *Figure 14*)
15. Apply butyl tape around the perimeter of the shifter box as shown in *Figure 15*.
16. With the aid of another person, install the shifter box assembly ensuring that the transfer case cable is routed under the transmission cooler line. (See *Figure 16*)
17. Bolt the shifter box assembly down using an 8 mm socket and the [] previously.

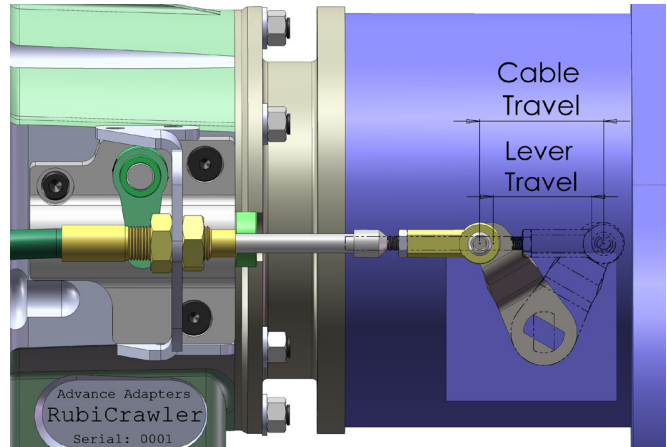

Figure 33: Transfer Case Cable Adjustment



Figure 14: RubiCrawler Cable Routing



Figure 16: Shifter Box Assembly w/ T-Case Cable



Figure 15: Apply Butyl Tape

SPECIAL NOTE: The components packaged in this kit have been assembled and machined for specific type of conversions. Modifications to any of the components will void any possible warranty or return privileges. If you do not fully understand modifications or changes that will be required to complete your conversion, we strongly recommend that you contact our sales department for more information. This instruction sheet is only to be used for the assembly of Advance Adapter components. We recommend that a service manual pertaining to your vehicle be obtained for specific torque values, wiring diagrams and other related equipment. These manuals are normally available at automotive dealerships and parts stores.

RUBICRAWLER - JEEP TJ W/NP231 & NP241

18. Move the transmission shifter into the "Neutral" position with the twin stick handles in the vertical position. Point the front of the console towards the passenger side, then rotate the console CCW as you maneuver it down over the twin stick handles and transmission shifter. Bolt the console down using a 10mm socket and the two bolts removed earlier. Install the shift indicator back on to the console making sure to plug in the indicator bulb before snapping it back in to place. (See Figure 17)
19. Install the new shift knobs using the supplied 3/8-16x1-1/4" flat head cap screws. The transfer case knob mounts on the driver side, and the RubiCrawler knob mounts on the passenger side.

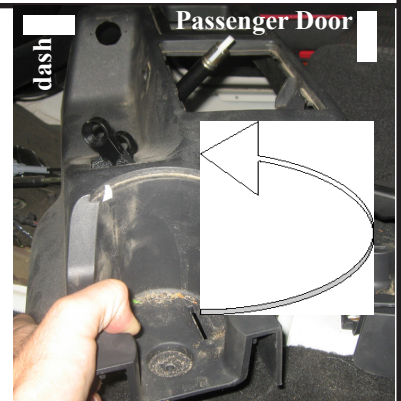

Figure 17: Console Install

Reassembly:

1. Install the foot mount with the four supplied 10 mm hex head bolts and washers.
2. Reinstall drive shafts and skid plates.

Transmission Fluid Re-Fill:

Caution: under filling or over filling can result in damage to your transmission. Only use Mopar approved, ATF+4 to refill the transmission.

1. Park on a flat surface and apply parking brake.
2. Start the engine and let the vehicle idle.
3. Apply the brakes and shift the transmission through all of the gears, then back to NEUTRAL and leave the vehicle idling.
4. Check the transmission fluid level with the dipstick. Using a clean funnel, add ATF+4 transmission fluid until the oil level is between the two holes marked "COLD". (Check to see if the transmission fluid level on the dipstick is even on both sides. If one side is noticeably higher than the other, the dipstick has picked up some fluid from the fill tube. Allow the fluid to drain down the transmission fill tube and recheck.
5. Now that the fluid level has been approximately achieved, drive the vehicle 5-10 miles making sure to manually shift the transmission through all gears.
6. Recheck the fluid level, with the transmission at operating temperature, vehicle idling on flat ground, the parking brake set, and the transmission in neutral. Add ATF+4 to raise the fluid level to a point between the two holes marked "HOT". Do this slowly so that the transmission fill tube has time to drain and gives accurate readings.

NOTE: For proper operation of the RubiCrawler, refer to the Shifting Procedure/Warranty paperwork and the yellow tag attached to the RubiCrawler case.

SPECIAL NOTE: The components packaged in this kit have been assembled and machined for specific type of conversions. Modifications to any of the components will void any possible warranty or return privileges. If you do not fully understand modifications or changes that will be required to complete your conversion, we strongly recommend that you contact our sales department for more information. This instruction sheet is only to be used for the assembly of Advance Adapter components. We recommend that a service manual pertaining to your vehicle be obtained for specific torque values, wiring diagrams and other related equipment. These manuals are normally available at automotive dealerships and parts stores.

RUBICRAWLER - JEEP TJ W/NP231 & NP241

Final Shift Lever Adjustment:

1. Check the position of the levers through the console, adjustments can be made by adjusting the cable barrels below the shifter box assembly. For proper adjustment and adjusted clearance see *Figures 34 & 35*. The transfer case shift lever should change to approximately. 1.25" from the console after installation and final adjustment.



*Figure 34:
Proper
Adjustment
in Farthest
Forward
Position*



*Figure 35: Proper Adjustment
with transfer case in 4Low and
the RubiCrawler in High*



*Figure 32: New Transfer Case
Shift Lever Orientation NP231*

SPECIAL NOTE: The components packaged in this kit have been assembled and machined for specific type of conversions. Modifications to any of the components will void any possible warranty or return privileges. If you do not fully understand modifications or changes that will be required to complete your conversion, we strongly recommend that you contact our sales department for more information. This instruction sheet is only to be used for the assembly of Advance Adapter components. We recommend that a service manual pertaining to your vehicle be obtained for specific torque values, wiring diagrams and other related equipment. These manuals are normally available at automotive dealerships and parts stores.

RUBICRAWLER - JEEP TJ W/NP231 & NP241

SHIFTING INSTRUCTIONS

Transfer Case Shifting: The transfer case can be shifted from two wheel drive to 4 wheel drive HIGH while the vehicle is moving. To shift the transfer case into four wheel drive LOW, you must shift the transmission to neutral and the vehicle speed must be below 2 mph. The transfer case can be shifted at a complete stop but it is easier to shift the unit when at a very slow roll.

RubiCrawler Shifting: The RubiCrawler must be shifted when the transmission is in neutral and the vehicle speed is less than 2 mph. The RubiCrawler can be shifted at a complete stop but it is easier to shift the unit when at a very slow roll. Do NOT try to force the shift levers as serious damage to the shifters or unit can occur.

Serious damage to the RubiCrawler can occur if the proper shifting instructions are not followed.

Shift Knobs and Shift Patterns

The shift knobs and patterns can be seen below and on the next page.



SPECIAL NOTE: The components packaged in this kit have been assembled and machined for specific type of conversions. Modifications to any of the components will void any possible warranty or return privileges. If you do not fully understand modifications or changes that will be required to complete your conversion, we strongly recommend that you contact our sales department for more information. This instruction sheet is only to be used for the assembly of Advance Adapter components. We recommend that a service manual pertaining to your vehicle be obtained for specific torque values, wiring diagrams and other related equipment. These manuals are normally available at automotive dealerships and parts stores.

RUBICRAWLER - JEEP TJ W/NP231 & NP241

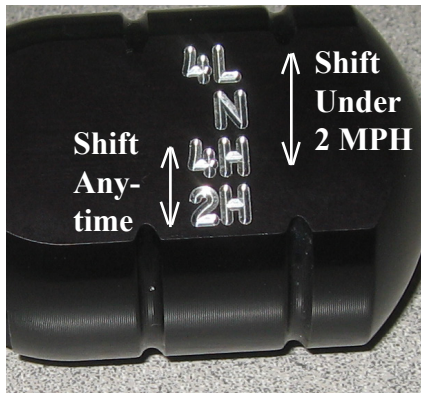

TJ Non-Rubicon Knob

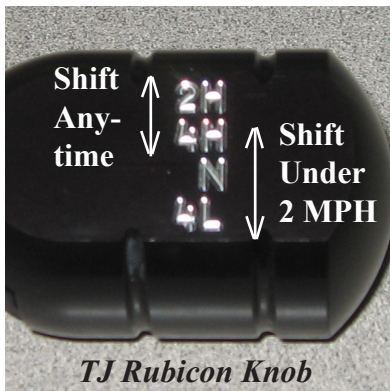

TJ Rubicon Knob

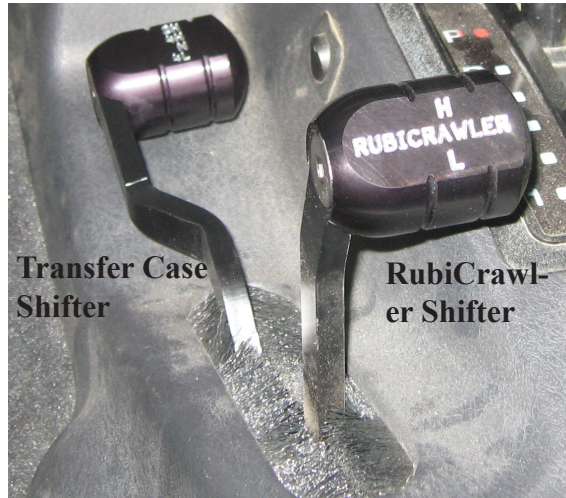

TJ Shift Knobs

Maximum Speed: The Rubi-Crawler should not be operated at engine speeds above 5000rpm when the transmission is in overdrive. This over speed condition will cause damage to the bearings and geartrain in the RubiCrawler, in addition to possible damage to other components in the vehicle.

ADVANCE ADAPTERS, INC. LIMITED WARRANTY

The RubiCrawler is guaranteed against defects in workmanship and materials for one year. This warranty begins from the date the unit is shipped from Advance Adapters. We log all units with a serial number at time of shipping. The warranty is void (as determined by Advance Adapters, Inc.) by misuse, abuse, improper maintenance or installation and or alterations to the product.

These guarantees do not cover any outside labor, shipping, towing, normal wear or any other unforeseen events that that may occur due to failure of a unit. Advance Adapters reserves the right to repair or replace any product.

Do not disassemble or attempt to repair the RubiCrawler as doing so will void the warranty, just return the product as further described below.

All returns must have a returned goods authorization (RGA#) prior to shipping the product, and returns are to be sent prepaid freight. Please call 1-800-350-2223 and the sales department can assist you.

Warranty will be voided if the proper transmission fluid levels are not maintained, if any transmission fluid other than ATF+4 is used, or the product has not been properly installed and instructions have not been followed.

SPECIAL NOTE: The components packaged in this kit have been assembled and machined for specific type of conversions. Modifications to any of the components will void any possible warranty or return privileges. If you do not fully understand modifications or changes that will be required to complete your conversion, we strongly recommend that you contact our sales department for more information. This instruction sheet is only to be used for the assembly of Advance Adapter components. We recommend that a service manual pertaining to your vehicle be obtained for specific torque values, wiring diagrams and other related equipment. These manuals are normally available at automotive dealerships and parts stores.